

SARS: Safeguards Accounting and Reporting Software

B. Mohammedi, S. Saadi, S. Ait-Mohamed
Centre de Recherche Nucléaire de Birine, COMENA, BP180, Ain Oussera, 17200, Algérie.
Tél: +213 27872936, Fax: +213 27874280

Abstract

In order to satisfy the requirements of the SSAC (State System for Accounting and Control of nuclear materials), for recording and reporting objectives; this computer program comes to bridge the gap between nuclear facilities operators and national inspection verifying records and delivering reports. The SARS maintains and generates at-facility safeguards accounting records and generates international atomic energy (IAEA) safeguards reports based on accounting data input by the user at any nuclear facility. A database structure is built and BORLAND DELPHI programming language has been used. The software is designed to be user-friendly, to make extensive and flexible management of menus and graphs.

SARS functions include basic physical inventory tacking, transaction histories and reporting. Access controls are made by different passwords.

Keywords: SSAC, SARS, safeguards, records, reports, transactions.

1. Introduction

What is Safeguards? One definition is knowing where and how much special nuclear material (U, Pu) is in a facility. Another definition is the ability to detect the movement of nuclear material to locations where it should not be, that is, the ability to detect a diversion, for which, timeliness is important in updating material inventories and material balance (IAEA safeguards, 1980). Each state shall establish and maintain a system of accounting for and control of all nuclear materials subject to safeguards under agreements between the state and the agency (Massendari et al, 2002), (Vidal et al, 2003).

The purpose of this work, based on IAEA Code 10, is to implement a computer tool for safeguards operators, to fulfill requirements of the SSAC in all peaceful nuclear activities in a state (IAEA. course, 2003). SARS is a PC-based application that is being developed as part of the national SSAC for Material control and accountability.

This program is developed using Borland Delphi Object Oriented programming language with database management system (Ewing et al, 1999) and runs well under Microsoft Windows XP. Before using the program for the first time, it needs to be installed by executing the set-up wizard and following instructions till finish. Direct access icon on the desk will be created automatically in addition to the program directory. The main SARS features are:

1. Physical inventory accounting.
2. Transactions recording.
3. Principal reporting.
4. Multiple item transfers within and between MBA's and KMP's.
5. Import/export to/from facilities.
6. Communication between different applications.

Nuclear reactor, from the safeguards point of view, is considered as a material balance area (MBA) with key measurement points, flow KMP 1,2,3.. and inventory KMP A,B,C.. as shown below in Fig.1.

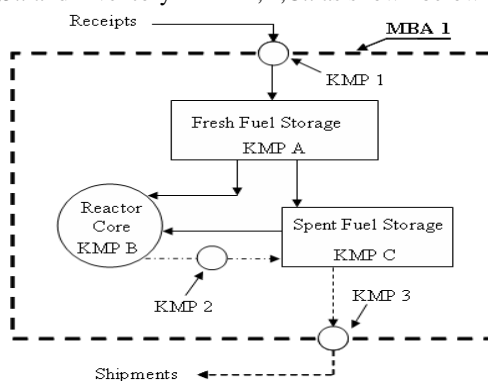

Fig.1. Nuclear material flow sheet in normal operation

2. Code 10 of Subsidiary Arrangements

This code is the general part of subsidiary arrangements in a safeguards agreement it defines the content, the format and the structure of accounting reports provided by the state to the Agency for each material balance area, an inventory change report (ICR) showing all changes in the inventory of nuclear material, a material balance report (MBR) showing the material balance based on a physical inventory of nuclear material actually present in the material balance area and a physical inventory listing (PIL) which specify, separately, identification and batch data for each batch of nuclear material. It can also add concise notes describing, as specified in the subsidiary Arrangements, any event, or an explanation text. All report must contain identification of the country by one or two characters, the facility code by three characters beginning by country code, the material area by four characters beginning by country code, and the report

type with number, period and operator name, in addition to the inventory and any previous modifications. The other standard codes concerning material type (element and isotope code Fig.9), measurement basis and material description (physical form Fig.10, chemical form containment, irradiation status and quality).

The processing of nuclear material accounting reports at the IAEA is resumed below:

- 1- Reports received daily;
- 2- Acknowledge receipt to the sender;
- 3- Provide summary of data received;
- 4- Correspond on problems;
- 5- Dispatch statements to states
 - a. Consolidated book inventory;
 - b. Transit matching;
 - c. Timeliness.

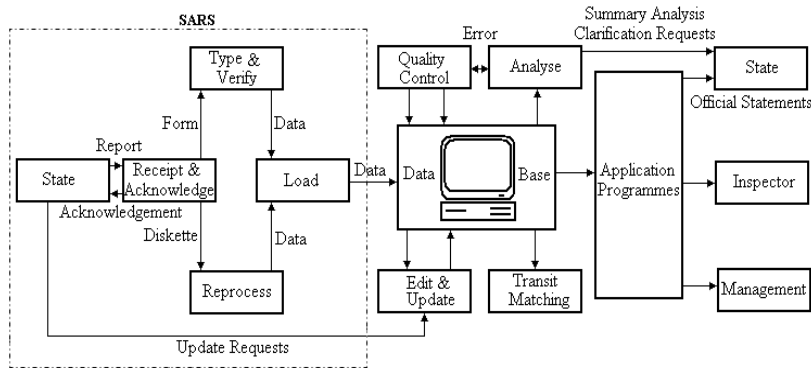

Fig.2. IAEA processing of accounting reports

3. Basic functionality

The system consists of a database foundation with additional sub-programs. For user interface, nine light buttons are mouse drag and click activated. Four of them are principals, initialization, transactions, records, and reports (Fig.3).

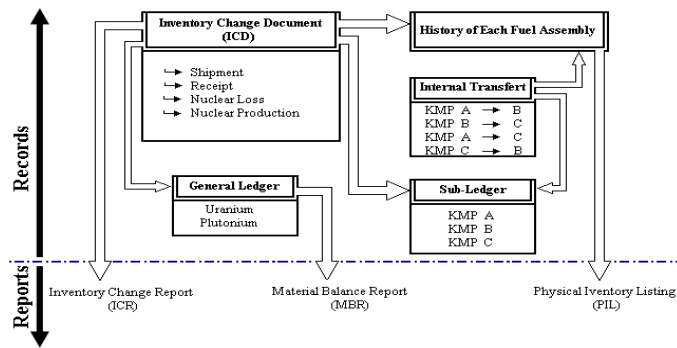

Fig.3. Basic functionality

3.1. Initialization

At the beginning of a new material balance period, the initialization screen (Fig.4), allows the user asked to enter the general information as the country code, the facility code, the operator name, the initialization date, and the MBA code. Inside the MBA, flow and inventory KMP's are also required. As long as, all facilities, MBA's and KMP's are given, the user is asked to save/cancel or close window.

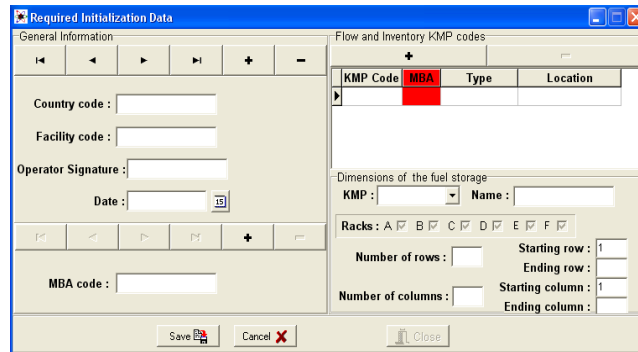

Fig.4. Data initialization screen

3.2. Transactions

Once the system has been initialized, it is ready to start nuclear material transactions (Ruth et al, 1991), (Fig.5), by first filling up database tables for initially received nuclear materials, the user choose the occurring transaction, for which is asked either to print, save, cancel, close or to see the fuel assemblies history card FAHC. Ten transactions are estimated to take place



Fig.5. Possible nuclear material transactions screen

SARS has the capability to handle single or multiple item movements (transactions) within an MBA (intra-MBA transaction) or between MBAs (inter-MBA transaction). For a multiple item movement, the user can either check off which items to move. For each transaction, the movement is performed immediately and the physical inventory and historical data tables are updated. The figure below (Fig.6) shows the material movements and automatically creates, prepares, updates and generates Records & Reports.

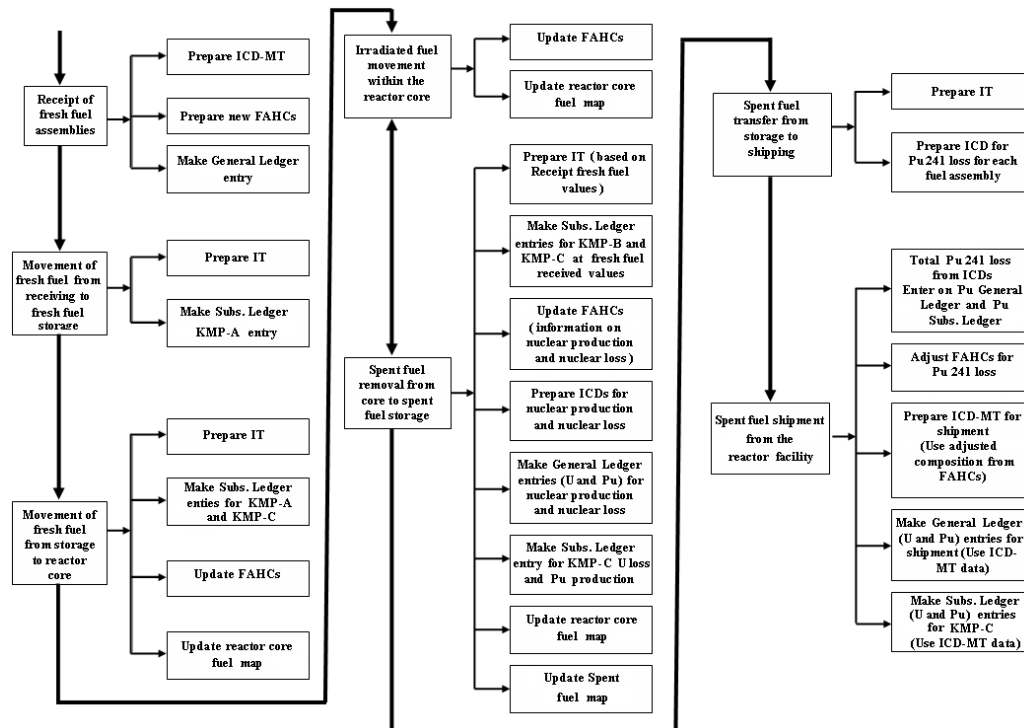

Fig.6. Nuclear material movements and accounting documentation for each (KEMPF et al, 1991)

3.3. Records

The SARS maintain a system of accounting and operating records for each MBA (Fig.7 and Fig.8). The accounting records is to reflect

1. All inventory changes, so as to permit a determination of the book inventory at any time;
2. All measurement results that are used for determination of the physical inventory;
3. All adjustments and correction that have been made in respect of inventory changes, book inventories and physical inventories.

Fig.7. Receipt of fresh fuel assemblies transaction screen

Fig.8. Nuclear loss and nuclear production transaction screen

One of the following keywords or their codes (Fig. 9) should be used in one of column of ICRs in order to indicate the type of inventory change.

Fig.9. Inventory change code (ICC)

Fig.10. Example of material description code (Character (1): Physical form)

In addition, another column (ICRs) should be used to describe the nuclear material by the use of four characters which consist of one alphabetic or numeric character:

- Character (1): Physical form (Fig.10);
- Character (2): Chemical form;
- Character (3): Containment;
- Character (4): Irradiation status and quality.

3.4. Reports

The principal task of the SARS is printing out the required IAEA safeguards reports according to the formats specified in code 10. Currently, SARS can generate the following reports: inventory change reports (ICR), physical inventory listing (PIL Fig.13) and material balance reports (MBR Fig.14), eventually concise notes and any custom reports added by the facility. The Figure12 explaining specific entries in reports

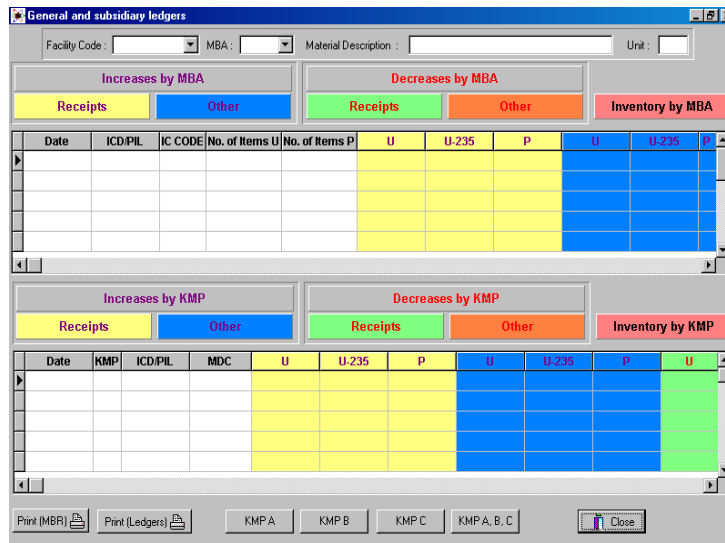

Fig.11. General and subsidiary ledger screen

Each MBA, report or entry in a report may be referred to be a concise note to explain or elaborate on the information provided in the report. A concise note is frequently used to provide the recipient's name for shipment, the effective burn-up for report of nuclear production and nuclear loss, explanation of accidental gain/loss, or the reason for correction Fig.12.

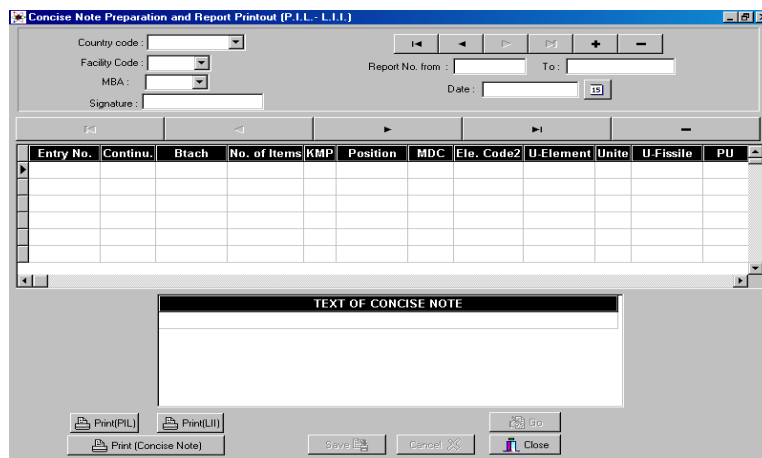

Fig.12. Concise note and reports printout buttons

PHYSICAL INVENTORY LISTING (PIL) FORM R.02/c													
COUNTRY :						DATE :							
FACILITY :						REPORT No.							
MATERIAL BALANCE AREA :						PAGE No.		OF		PAGES		SIGNATURE :	
ENTRY No.	CONTINUATION	KMP CODE	NAME OR NUMBER OF BATCH	NUMBER OF ITEMS IN BATCH	MATERIAL DESCRIPTION	ACCOUNTANCY DATA					CORRECTION TO		
						ELEMENT	WEIGHT OF ELEMENT	UNIT Kg/g	WEIGHT OF FISSILE ISOTOPES (URANIUM ONLY) (G)	ISOTOPE CODE	MEASUR. BASIS	CONCISE NOTE	REPORT No.
1													
2													
3													
4													
5													
6													
7													
8													
9													
10													
11													
12													
13													
14													
15													
16													

Fig.13. PIL Printout

MATERIAL BALANCE REPORT (MBR) FORM R.03													
COUNTRY :						REPORTING PERIOD. FROM						TO	
FACILITY :						REPORT No.							
MATERIAL BALANCE AREA :						PAGE No.		OF		PAGES		SIGNATURE :	
ENTRY No.	CONTINUATION	ENTRY NAME	ELEMENT	WEIGHT OF ELEMENT	UNIT Kg/g	WEIGHT OF FISSILE ISOTOPES (URANIUM ONLY) (g)	ISOTOPE CODE	CONCISE NOTE	CORRECTION TO				
									REPORT No.	ENTRY No.			
1													
2													
3													
4													
5													
6													
7													
8													
9													

Fig.14. MBR Printout

3.5. F.A.H.C

One important feature of (SARS) is the Fuel Assembly Historical Card (Fig.15) display since receipt of fresh fuel until its expedition passing through intermediates transactions such as its update during his movement to reactor core, its irradiation within reactor core and its adjustment in its expedition movement.

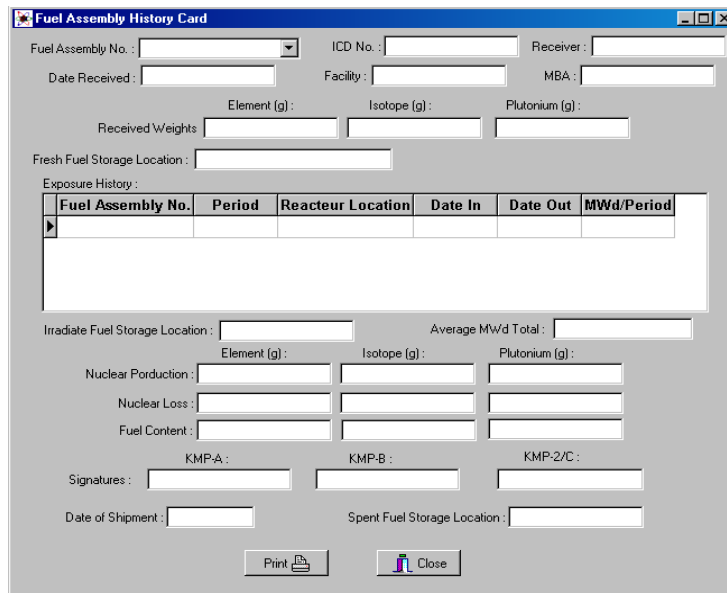

Fig.15. Fuel Assembly Historical Card screen

FUEL ASSEMBLY HISTORY CARD

Facility :
ICD No :

MBA :
Date Received :

Fuel Assembly No. :	Weight	g U	Weight	g U-235	Weight	g Pu
Received Weights		g U		g U-235		g Pu

Fresh Fuel Storage Location :

Exposure History :

Period	Reactor Location	Date In	Date Out
1			

Irradiated Fuel Storage Location :

Average MWd/t :

Nuclear Production :					g Pu
Nuclear Loss :		g U		g U-235	g Pu
Fuel Content :		g U		g U-235	g Pu

Signatures :

KMP-A
KMP-B
KMP-2/C

Date of Shipment :

Receiver :

ICD No. :

Fig.16. FAHC Printout

4. Conclusion

This program has been designed to be highly flexible and configurable, and to support a wide range of facility requirements. It is an easy to use and efficient way to keep records and prepare national and IAEA reports. The main focus of this tool has been reached by the implementation of main parts of the program, such as different transactions, records and producing different reports. It remains more work to do in order to achieve better degree of quality by building a database for all controlled nuclear materials.

Algerian specialists are testing and evaluating this program against actual and future needs in order to produce a good version of this program which can be used by the facilities in routine operation.

References

- T.Ewing, C.McWilliams, A.Olson, C.Roche, H.Forsman, and G.Walters, 1999. MC&A Software Assistance to Ukraine. Argon National Laboratory, Los Alamos National Laboratory, Oak Ridge National laboratory.
- KEMPF, C.R., BIEBER, A.M., JR., 1991, "SARP: A Safeguards Accounting and Reports Program", Journal of Nuclear Materials Management (Vol. XX No. 1) 24-30.
- Massendari, B, J.Jalouneix. 2002, Experience in the Application of French Regulations regarding the Control and Accounting of nuclear Material. IRSN. Direction de l'expertise nucleaire de defense. Cadarache Saint Paul Lez Durance (13) France.
- Vidal.H, Thaurel.B, Franklin.M, Isaev.N.2003. Joint study of state systems of Nuclear Materials Control and Accountancy in Russia and in France. IRSN. BP17 F92262 Fontenay aux roses Cedex, JRC-IPSC. Ispra-Italy, VNIIA. MOSCOW.
- IAEA, International course about implementation of SSAC. From 20 to 31 October 2003, Held at Pretoria, South Africa.
- IAEA safeguards.1980, Guidelines for SSAC, Vienna.